

合肥中恒微半导体有限公司

HeFei Cpower Technology,Ltd.

TLC450M07S1PSN



➤ 产品外观 / Appearance

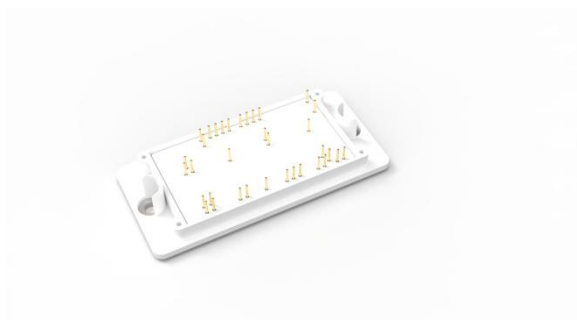

$V_{CES} = 650V$

$I_{C\ nom} = 450A / I_{CRM} = 900A$

➤ 特性 / Features

- a) Neutral Point Clamped Three-Level Inverter Module
- b) 650 V Field Stop 4 IGBTs
- c) Low Inductive Layout
- d) Thermistor

➤ 用途 / Applications

- a) Solar Inverters
- b) Uninterruptable Power Supplies Systems
- c) 3-Level-Applications

➤ 相关信息 / Related Information

条形码 / Barcode Code



二维码 / DMX – Code



公司地址：合肥市高新区创新大道与明珠大道交叉口 106 号 5 号楼 2 层 C 区、D 区。

Address: Area C and D, 2nd floor, Building 5, No. 106, Intersection of Innovation Avenue and Mingzhu Avenue, High-tech Zone, Hefei City.

TLC450M07S1PSN



IGBT (Q1-1,Q1-2,Q4-1,Q4-2)

最大额定值/Maximum Rated Values

集电极-发射极电压 Collector-Emitter voltage	$T_J=25^\circ\text{C}$	V_{CES}	650	V
连续集电极直流电流 Continuous DC collector current	$T_C = 100^\circ\text{C}, T_J \text{ max} = 175^\circ\text{C}$	$I_{C \text{ nom}}$	225	A
集电极重复峰值电流 Repetitive peak collector current	$T_P=1\text{ms}$	I_{CRM}	450	A
栅极-发射极峰值电压 Gate-emitter peak voltage		V_{GES}	+/-30	V

电特性/Electrical Characteristics ($T_J = 25^\circ\text{C}$ unless otherwise noted)

Parameter	Test Conditions	Symbol	Min	Typ	Max	Unit
Outer IGBT (Q1-1, Q1-2, Q4-1, Q4-2)						
集电极-发射极饱和电压 Collector-Emitter Saturation Voltage	$V_{GE} = 15 \text{ V},$ $I_C = 225 \text{ A}$	$T_J = 25^\circ\text{C}$ $T_J = 125^\circ\text{C}$	$V_{CE(sat)}$	1.35 1.50		V
栅极-发射极阈值电压 Gate-Emitter Threshold Voltage	$V_{GE} = V_{CE}, I_C = 7.4 \text{ mA}$		$V_{GE(th)}$	5.79		V
内部栅极电阻 Internal gate resistor	$T_J = 25^\circ\text{C}$		R_{Gint}	3.75		Ω
输入电容 Input Capacitance	$V_{CE} = 25 \text{ V}$ $V_{GE} = 0 \text{ V}$		C_{ies}	7200		pF
输出电容 Output Capacitance	$f = 1 \text{ MHz}$		C_{oes}	180		
集电极-发射极截止电流 Collector-Emitter Cut-off Current	$V_{GE} = 0 \text{ V}, V_{CE} = 650 \text{ V}$		I_{CES}		1	μA
栅极峰值电流 Gate Leakage Current	$V_{GE} = 20 \text{ V}, V_{CE} = 0 \text{ V}$		I_{GES}		500	nA
开通延迟时间 Turn-on Delay Time	$V_{CE} = 400 \text{ V},$ $I_C = 100 \text{ A},$ $V_{GE} = -5 \text{ V to } +15 \text{ V},$ $R_{G(on)} = 15\Omega$ $R_{G(off)} = 15\Omega$	$T_J = 25^\circ\text{C}$ $T_J = 125^\circ\text{C}$	$t_{d(on)}$	297 262		ns
上升时间 Rise Time		$T_J = 25^\circ\text{C}$ $T_J = 125^\circ\text{C}$	t_r	129 139		
关断延迟时间 Turn-off Delay Time		$T_J = 25^\circ\text{C}$ $T_J = 125^\circ\text{C}$	$t_{d(off)}$	881 983		
下降时间 Fall Time		$T_J = 25^\circ\text{C}$ $T_J = 125^\circ\text{C}$	t_f	244 326		
开通损耗能量 Turn-on Switching Loss per Pulse		$T_J = 25^\circ\text{C}$ $T_J = 125^\circ\text{C}$	E_{on}	7.99 9.89		mJ
关断损耗能量 Turn off Switching Loss per Pulse		$T_J = 25^\circ\text{C}$ $T_J = 125^\circ\text{C}$	E_{off}	10.26 11.92		

TLC450M07S1PSN



IGBT (Q1-1,Q1-2,Q4-1,Q4-2)

总栅极电荷 Total Gate Charge	$V_{CE} = 480 \text{ V}$, $I_C = 225 \text{ A}$, $V_{GE} = \pm 15 \text{ V}$	Q_g		1080		nC
芯片-散热器热阻 Thermal Resistance – chip-to-heatsink	Thermal grease, Thickness = 2 Mil $\pm 2\%$, $\lambda = 2.8 \text{ W/mK}$	R_{thJH}		0.33		$^{\circ}\text{C/W}$
芯片-外壳热阻 Thermal Resistance – chip-to-case		R_{thJC}		0.17		$^{\circ}\text{C/W}$
开关状态下温度 Temperature under switching		T_{jop}	-40		150	$^{\circ}\text{C}$

TLC450M07S1PSN



二极管/Diode (D5,D6)

最大额定值/Maximum Rated Values

反向重复峰值电压 Repetitive peak reverse voltage	$T_j = 25^\circ\text{C}$	V_{RRM}	650	V
连续正向直流电流 Continuous DC forward current		I_F	300	A
正向重复峰值电流 Repetitive peak forward current	$t_p = 1\text{ ms}$	I_{FRM}	600	A

电特性 / Electrical Characteristics ($T_j = 25^\circ\text{C}$, unless otherwise noted)

Parameter	Test Conditions	Symbol	Min	Typ	Max	Unit
NEUTRAL POINT DIODE (D5, D6)						
二极管正向电压 Diode Forward Voltage	$I_F = 375\text{ A}$	$T_j = 25^\circ\text{C}$ $T_j = 125^\circ\text{C}$	V_F	1.60 1.55	2.3	V
反向恢复电流 Reverse Recovery Time		$T_j = 25^\circ\text{C}$ $T_j = 125^\circ\text{C}$	t_{rr}	70 95		ns
反向恢复电荷 Reverse Recovery Charge	$V_{CE} = 400\text{ V},$ $I_C = 100\text{ A},$	$T_j = 25^\circ\text{C}$ $T_j = 125^\circ\text{C}$	Q_{rr}	2.0 5.0		μC
反向恢复峰值电流 Peak Reverse Recovery Current	$V_{GE} = -5\text{ V to } +15\text{ V},$ $R_G = 15\Omega$	$T_j = 25^\circ\text{C}$ $T_j = 125^\circ\text{C}$	I_{RRM}	60 110		A
反向恢复能量 Reverse Recovery Energy		$T_j = 25^\circ\text{C}$ $T_j = 125^\circ\text{C}$	E_{rr}	0.9 1.45		mJ
芯片-散热器热阻 Thermal Resistance – chip-to-heatsink	Thermal grease, Thickness = 2 Mil $\pm 2\%$,	R_{thjH}		0.40		$^\circ\text{C}/\text{W}$
芯片-外壳热阻 Thermal Resistance – chip-to-case	$\lambda = 2.8\text{ W/mK}$	R_{thjC}		0.36		$^\circ\text{C}/\text{W}$
在开关状态下温度 Temperature under switching		T_{jop}	-40		150	$^\circ\text{C}$

TLC450M07S1PSN



IGBT (Q2,Q3)

最大额定值/Maximum Rated Values

集电极-发射极电压 Collector-Emitter voltage	$T_J=25^{\circ}\text{C}$	V_{CEs}	650	V
连续集电极直流电流 Continuous DC collector current	$T_C = 100^{\circ}\text{C}, T_J \text{ max} = 175^{\circ}\text{C}$	$I_{c \text{ nom}}$	375	A
集电极重复峰值电流 Repetitive peak collector current	$T_P=1\text{ms}$	I_{CRM}	750	A
栅极-发射极峰值电压 Gate-emitter peak voltage		V_{GES}	+/-30	V

电气特性 / Electrical Characteristics ($T_J = 25^{\circ}\text{C}$ unless otherwise noted)

Parameter	Test Conditions	Symbol	Min	Typ	Max	Unit
Inner IGBT (Q2, Q3)						
集电极-发射极饱和电压 Collector-Emitter Saturation Voltage	$V_{GE} = 15\text{ V},$ $I_C = 225\text{ A}$	$T_J = 25^{\circ}\text{C}$ $T_J = 125^{\circ}\text{C}$	$V_{CE(sat)}$	1.50 1.72		V
栅极-发射极阈值电压 Gate-Emitter Threshold Voltage	$V_{GE} = V_{CE}, I_C = 3.75\text{ mA}$		$V_{GE(th)}$	5.78		V
内部栅极电阻 Internal gate resistor	$T_J = 25^{\circ}\text{C}$		R_{Gint}	1.7		Ω
输入电容 Input Capacitance	$V_{CE} = 20\text{ V},$ $V_{GE} = 0\text{ V},$ $f = 10\text{ kHz}$		C_{ies}	5200		pF
反向传输电容 Reverse Transfer Capacitance				C_{res}		
集电极-发射极截止电流 Collector-Emitter Cut-off Current	$V_{GE} = 0\text{ V}, V_{CE} = 650\text{ V}$		I_{CES}		1	μA
栅极峰值电流 Gate Leakage Current	$V_{GE} = 20\text{ V}, V_{CE} = 0\text{ V}$		I_{GES}		500	nA
开通延迟时间 Turn-on Delay Time	$V_{CE} = 400\text{ V},$ $I_C = 100\text{ A},$ $V_{GE} = -5\text{ V to } +15\text{ V},$ $R_{G(on)} = 15\Omega,$ $R_{G(off)} = 15\Omega$	$T_J = 25^{\circ}\text{C}$ $T_J = 125^{\circ}\text{C}$	$t_{d(on)}$	206 187		ns
上升时间 Rise Time		$T_J = 25^{\circ}\text{C}$ $T_J = 125^{\circ}\text{C}$		t_r		
关断延迟时间 Turn-off Delay Time		$T_J = 25^{\circ}\text{C}$ $T_J = 125^{\circ}\text{C}$	$t_{d(off)}$			
下降时间 Fall Time		$T_J = 25^{\circ}\text{C}$ $T_J = 125^{\circ}\text{C}$		t_f		
开通损耗能量 Turn-on Switching Loss per Pulse		$T_J = 25^{\circ}\text{C}$ $T_J = 125^{\circ}\text{C}$	E_{on}			
关断损耗能量 Turn off Switching Loss per Pulse		$T_J = 25^{\circ}\text{C}$ $T_J = 125^{\circ}\text{C}$		E_{off}		
总栅极电荷 Total Gate Charge		$V_{CE} = 480\text{ V}, I_C = 375\text{ A},$ $V_{GE} = \pm 15\text{ V}$				

TLC450M07S1PSN



芯片-散热器热阻 Thermal Resistance - chip-to-heatsink	Thermal grease, Thickness = 2 Mil \pm 2%, λ = 2.8 W/mK	R_{thJH}		0.43		$^{\circ}\text{C}/\text{W}$
芯片-外壳热阻 Thermal Resistance - chip-to-case		R_{thJC}		0.22		$^{\circ}\text{C}/\text{W}$
开关状态下温度 Temperature under switching		T_{jop}	-40		150	$^{\circ}\text{C}$

TLC450M07S1PSN

二极管/Diodes (D1,D2,D3,D4)

负温度系数热敏电阻/NTC-Thermistor



最大额定值/Maximum Rated Values

反向重复峰值电压 Repetitive peak reverse voltage	$T_j = 25^\circ\text{C}$	V_{RRM}	650	V
连续正向直流电流 Continuous DC forward current		I_F	150	A
正向重复峰值电流 Repetitive peak forward current	$t_p = 1\text{ ms}$	I_{FRM}	300	A

反向二极管 / Inverse Diodes (D1, D2, D3, D4)

			Min.	Typ.	Max.	
二极管正向电压 Diode Forward Voltage	$I_F = 150\text{ A}$,	$T_j = 25^\circ\text{C}$	V_F	1.60	2.3	V
		$T_j = 125^\circ\text{C}$		1.55		
反向恢复时间 Reverse Recovery Time	$V_{CE} = 400\text{ V}$, $I_C = 100\text{ A}$ $V_{GE} = -5\text{ V to } +15\text{ V}$, $R_G = 15\Omega$	$T_j = 25^\circ\text{C}$	t_{rr}	70		ns
反向恢复电荷 Reverse Recovery Charge		$T_j = 125^\circ\text{C}$		95		
		$T_j = 25^\circ\text{C}$		Q_{rr}	2.0	
反向恢复峰值电流 Peak Reverse Recovery Current		$T_j = 125^\circ\text{C}$			4.5	
	反向恢复能量 Reverse Recovery Energy	$T_j = 25^\circ\text{C}$	I_{RRM}	60		A
$T_j = 125^\circ\text{C}$		86				
芯片-散热器热阻 Thermal Resistance – chip-to-heatsink	Thermal grease, Thickness = 2 Mil \pm 2%, $\lambda = 2.8\text{ W/mK}$	$T_j = 25^\circ\text{C}$	R_{thJH}	0.92		mJ
芯片-外壳热阻 Thermal Resistance – chip-to-case		$T_j = 125^\circ\text{C}$		1.62		
芯片-散热器热阻 Thermal Resistance – chip-to-heatsink	Thermal grease, Thickness = 2 Mil \pm 2%, $\lambda = 2.8\text{ W/mK}$		R_{thJH}	0.50		$^\circ\text{C/W}$
芯片-外壳热阻 Thermal Resistance – chip-to-case			R_{thJC}	0.36		$^\circ\text{C/W}$
开关状态下温度 Temperature under switching		$T_{j\text{ op}}$	-40		150	$^\circ\text{C}$

负温度系数热敏电阻 / NTC-Thermistor

特征值 / Characteristic Values

			Min.	Typ.	Max.	
额定阻值 Rated resistance	$T_C = 25^\circ\text{C}$	R25		22		k Ω
阻值误差 Deviation of R100	$T_C = 100^\circ\text{C}$, R100 = 1468 Ω	$\Delta R/R$	-5		5	%

TLC450M07S1PSN



功率损耗 Power dissipation	$T_c = 25^\circ\text{C}$	P25			200	mW
B 值/B – value	$R2=R25 \exp [B25/50(1/T2 - 1/(298.15K))]$	B25/50		3950		K
B 值/B – value	$R2=R25 \exp [B25/100(1/T2 - 1/(298.15K))]$	B25/100		3433		K

TLC450M07S1PSN



模块/Module

绝缘配置 / Insulation Coordination

隔离试验电压/Isolation test voltage	RMS, f = 50 Hz, t = 1 min	V_{ISOL}	4.2	kV
内部隔离/Internal Isolation	Basic insulation (class 1, IEC 61140)		Si_3N_4	
爬电距离/Creepage distance	Terminal to heatsink	dCreep	9.0	mm
爬电距离/Creepage distance	Terminal to terminal	dCreep	9.0	mm
间距/Clearance	Terminal to heatsink	dClear	4.5	mm
间距/Clearance	Terminal to terminal	dClear	4.5	mm
相对漏电起痕指数 Comparative tracking index		CTI	> 200	

特征值 / Characteristic Values

		Min.	Typ.	Max.	
杂散电感模块/Stray inductance module	LsCE	-40	8.5		nH
储存温度/Storage temperature	Tstg	20		125	°C
夹具的安装力/Mounting force per clamp	F			50	N
重量/Weight	G		188		g

TLC450M07S1PSN



封装/Package

电路拓扑/Circuit Topology

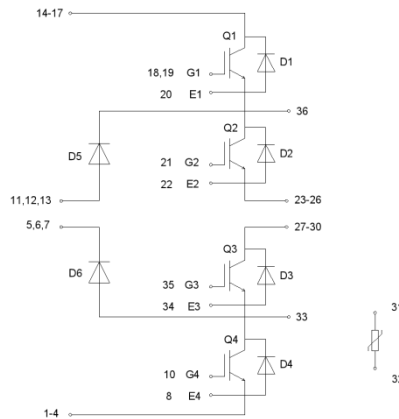

封装尺寸 / Package outlines

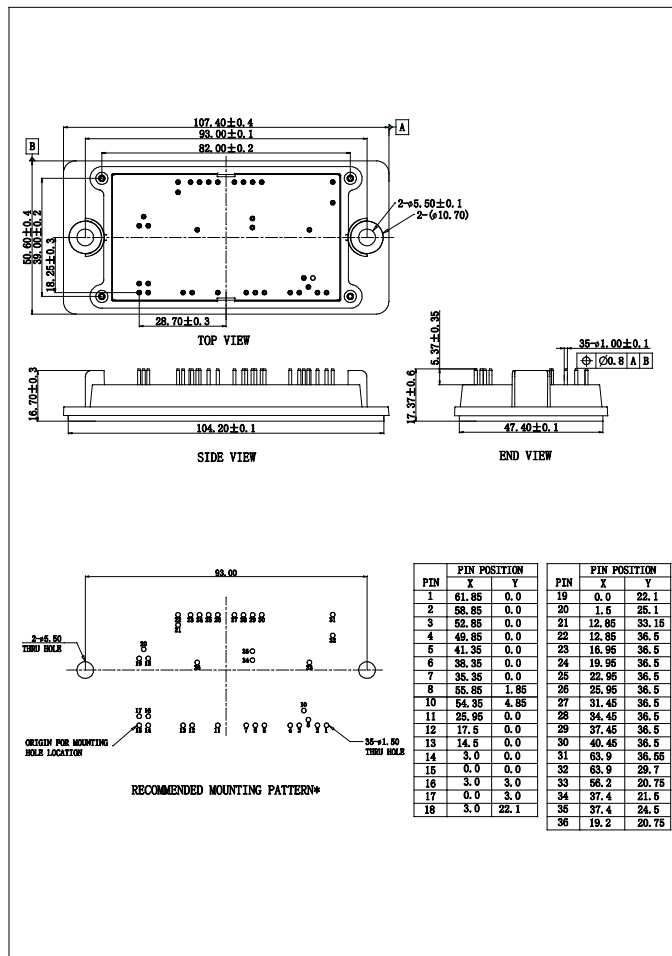

性能/Performance

输出特性 IGBT(Q1, Q4), 逆变器 (典型)

Output characteristic IGBT(Q1, Q4), Inverter (typical)

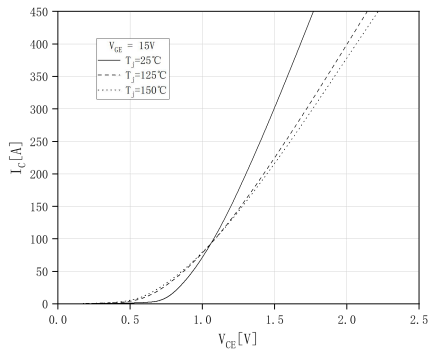

输出特性 IGBT(Q2, Q3), 逆变器 (典型)

Output characteristic IGBT(Q2, Q3), Inverter (typical)

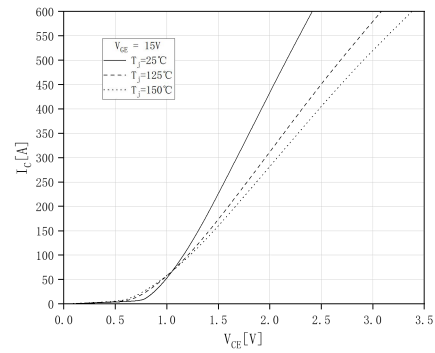

输出特性 IGBT(Q1, Q4), 逆变器 (典型)

Output characteristic IGBT(Q1, Q4), Inverter (typical)

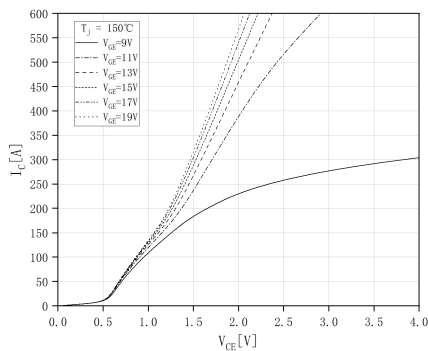

输出特性 IGBT(Q2, Q3), 逆变器 (典型)

Output characteristic IGBT(Q2, Q3), Inverter (typical)

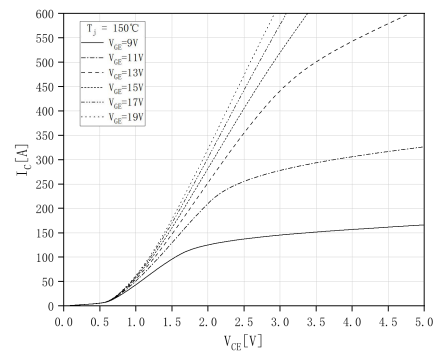

开关损耗 IGBT(Q1, Q4), 逆变器 (典型)

Switching losses IGBT(Q1, Q4), Inverter (typical)

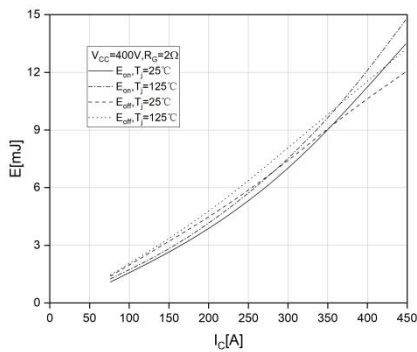

开关损耗 IGBT(Q2, Q3), 逆变器 (典型)

Switching losses IGBT(Q2, Q3), Inverter (typical)

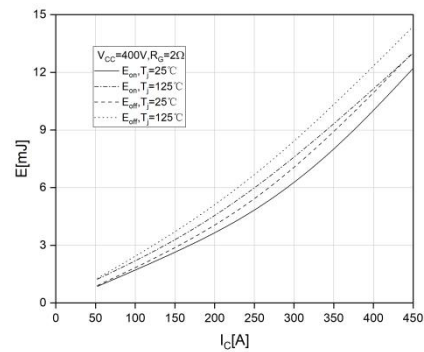

性能/Performance

开关损耗 IGBT(Q1, Q4), 逆变器 (典型)

Switching losses IGBT(Q1, Q4), Inverter (typical)

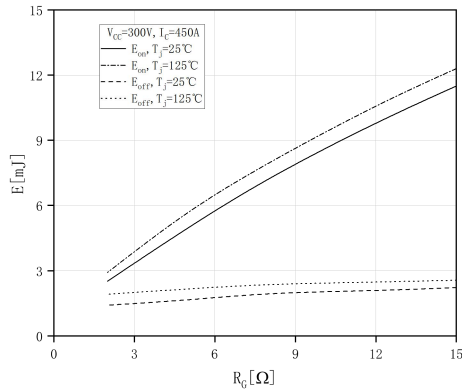

开关损耗 IGBT(Q2, Q3), 逆变器 (典型)

Switching losses IGBT(Q2, Q3), Inverter (typical)

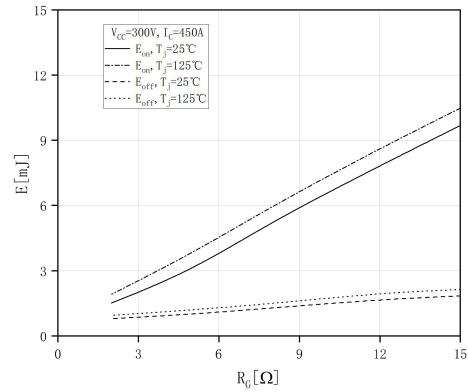

瞬态热阻抗 IGBT(Q1, Q4), 逆变器

Transient thermal impedance IGBT(Q1, Q4), Inverter

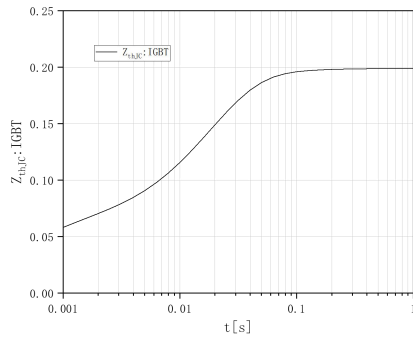

瞬态热阻抗 IGBT(Q2, Q3), 逆变器

Transient thermal impedance IGBT(Q2, Q3), Inverter

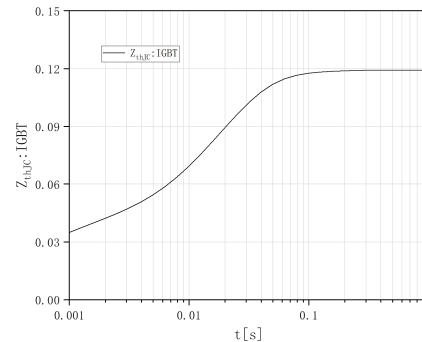

反偏安全工作区 IGBT, 逆变器 (RBSOA)

Reverse bias safe operating area IGBT, Inverter(RBSOA)

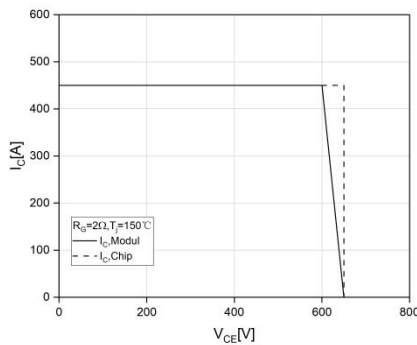

性能/Performance

正向偏压特性二极管(D1, D2, D3, D4),逆变器 (典型)

Forward characteristic of Diode(D1, D2, D3, D4), Inverter(typical)

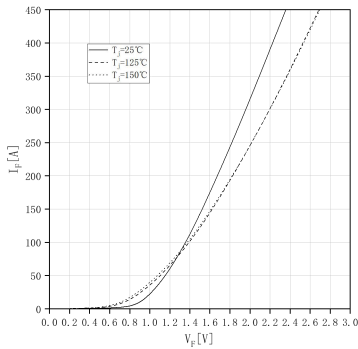

正向偏压特性 二极管(D5, D6),逆变器 (典型)

Forward characteristic of Diode(D5, D6), Inverter(typical)

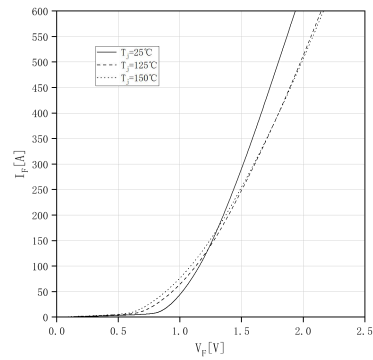

瞬态热阻抗 二极管, D5,D6

Transient thermal impedance Diode

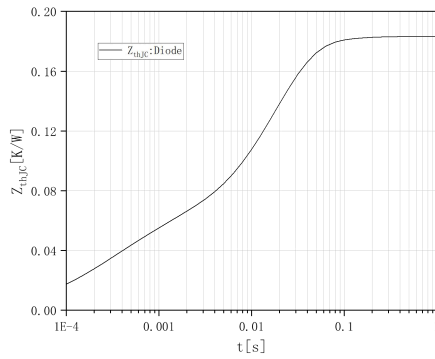

瞬态热阻抗 二极管, D1,D2,D3,D4

Transient thermal impedance Diode

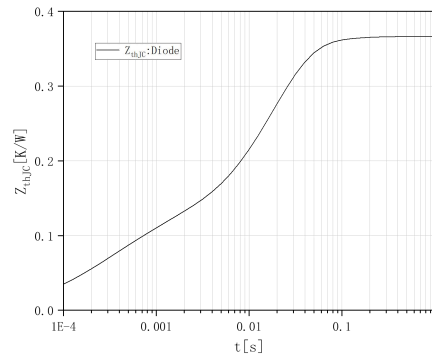

性能/Performance

开关损耗二极管(D1, D2, D3, D4), 逆变器 (典型)

Switching losses Diode(D1, D2, D3, D4), Inverter(typical)

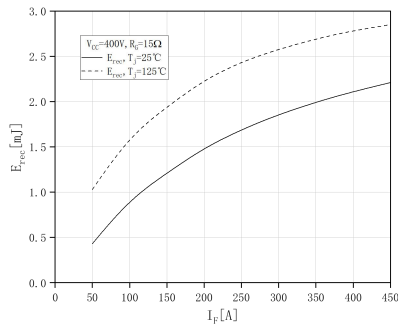

开关损耗二极管(D5, D6), 逆变器 (典型)

Switching losses Diode(D5, D6), Inverter(typical)

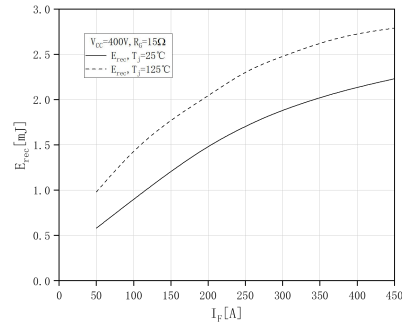

开关损耗 二极管(D1, D2, D3, D4), 逆变器 (典型)

Switching losses Diode(D1, D2, D3, D4), Inverter(typical)

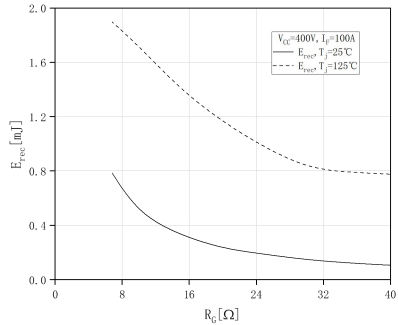

开关损耗 二极管(D5, D6), 逆变器 (典型)

Switching losses Diode(D5, D6), Inverter(typical)

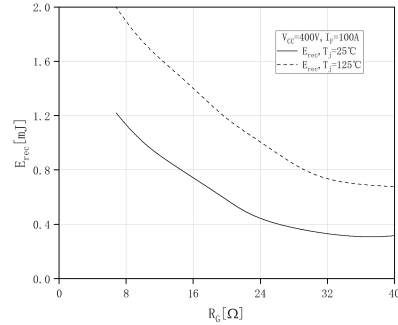

TLC450M07S1PSN

使用条件及条款

Terms & Conditions of usage



本档所提供的任何信息绝不应被视为针对任何条件或者品质而做出的保证（质量保证）。本公司对于本档中所提及的任何事例、提示或者任何特定数值及/或任何关于产品应用方面的信息均在此明确声明本公司不承担任何保证或者责任，包括但不限于其不侵犯任何第三方知识产权的保证均在此排除。

此外，本档所提供的任何信息均取决于客户履行本档所载明的义务和客户遵守适用于客户产品以及与客户对于本公司产品的应用所相关的任何法律要求、规范和标准。

本档所含的数据仅供经过专业技术培训的人员使用。客户自身的技术部门有义务对于产品是否适宜于其预期的应用和针对该种应用而言本档中所提供的信息是否充分自行予以评估。如需产品、技术、交付条款和条件以及价格等进一步信息，请向本公司接洽。

The information given in this document shall in no event be regarded as a guarantee of conditions or characteristics("quality guarantee"). With respect to any examples, hints or any typical values stated herein and/or any information regarding the application of the product, Cpower Technology hereby disclaims any and all warranties and liabilities of any kind, including without limitation warranties of non-infringement of intellectual property rights of any third party.

In addition, any information given in this document is subject to customer's compliance with its obligations stated in this document and any applicable legal requirements, norms and standards concerning customer's products and any use of the product of Cpower Technology in customer's applications.

The data contained in this document is exclusively intended for technically trained staff. It is the responsibility of customer's technical departments to evaluate the suitability of the product for the intended application and the completeness of the product information given in this document with respect to such application.

For further information on the product, technology, delivery terms and conditions and prices please contact Cpower Technology.